

*EUROFOX AVIATION, The hangar,
Wanshurstgreen Farm,
Battle lane, Marden, Kent,
TN12 9DF*



EuroFOX Aviation is a trading name of Ascent industries Ltd. Company registration nr 7731403

Pilot operating handbook

EuroFOX Aviation

EuroFOX

The EuroFOX aircraft design has been assessed by the CAA against BCAR Section S. The aircraft is a Type Approved Microlight under the ultimate supervision of the CAA.

Aircraft Type:

EuroFOX Aviation Approved Microlight Nose wheel and Tail wheel at 560 Kg MAUW

All performance figures in this POH are based on 560 kg MAUW.

Type Approved Microlight Serial Number:

Registration:

Date of Issue: 17 Feb 2023

A handwritten signature in black ink, consisting of a stylized 'M' followed by a horizontal line and a small flourish.

Stamp, Signature

AIRCRAFT DATA

	Type	Production	Serial Number:	Destination and year of production (if known)
Fuselage	EuroFOX Nose or Tail wheel	EUROFOX AVIATION		EuroFOX Aviation Luke's Field Kent
Engine	ROTAX 912 UL or 912 ULS or 912iS Sport or 915iS	BOMBARDIER -ROTAX GMBH AUSTRIA		
PROPELLER	DUC Swirl 1660 mm (80 hp)	DUC Helices, France Woodcomp CZ	S/N's	
	1730 mm (100hp)			
	DUC Flash 1850 mm (141hp)			
	Woodcomp Propuls AE174 (100hp)			
Parachute Safety system (if fitted)	Magnum 601 Light Speed	Stratos 07 s.r.o.	S/N	



.....
Stamp

.....
Signature

RECORD OF REVISIONS

Any revisions or amendments to the present manual shall be issued in the form of bulletins with attached new pages. It is in the interests of every user to enter such revision into the table of revisions and to replace the existing page by the new one. The revised or corrected text shall be indicated by a vertical line on left page margin and the page shall bear revision number and date of its issue.







Rev. No.	Pages Affected	Date of Issue	Change	New Page Inserted	Signature EuroFOX Aviation
1.0	All	September 2021	First issue. Based on the 450/472kg POH iss 7 with relevant amendments pursuant to higher MAUW of 560kgs		
2.0	All	Jan 22	Rotax 915iS engine added		
3.0	All	Feb 22	Rotax 912UL engine added		
4.0	All	May 22	Minor adjustments for 915iS approval		
5.0	All	Feb 23	Nose wheel 915iS, 850kg MAUW glider and Banner towing Minor ASI calibration corrections	POH Supplements for Glider and banner towing	
6.0	36	Sept 23	Tyre info		

TABLE OF CONTENTS:

1. GENERAL INFORMATION	- 7 -
1.1 INTRODUCTION	- 7 -
1.2 CERTIFICATION BASIS	- 7 -
1.3 MANUFACTURER	- 7 -
1.4 WARNING, CAUTION AND NOTE	- 7 -
2. AIRCRAFT AND SYSTEMS DESCRIPTION	- 8 -
2.1 NOSE WHEEL	- 8 -
2.2 TAIL WHEEL	- 9 -
2.3 ENGINE	- 10 -
2.4 UK APPROVED PROPELLERS FOR USE WITH YOUR TYPE APPROVED MICROLIGHT	- 10 -
2.5 FUEL AND FUEL CAPACITY	- 10 -
2.6 OIL	- 11 -
2.7 OIL WARMING FLAP	- 11 -
2.8 OPERATING WEIGHTS AND LOADING (OCCUPANTS, BAGGAGE, FUEL, BALLAST)	- 11 -
2.9 CREW	- 11 -
2.10 CABIN OVERVIEW (GUIDE ONLY)	- 12 -
2.11 CO MONITORING PATCH	- 14 -
2.12 AUTOPILOT	- 14 -
3. OPERATING LIMITATIONS	- 15 -
3.1 STALL SPEED AT MAXIMUM TAKE-OFF WEIGHT (V_S AND V_{SO})	- 15 -
3.2 FLAPS EXTENDED SPEED RANGE (V_{SO} TO V_{FE}) KIAS	- 15 -
3.3 MAXIMUM MANOEUVRING SPEED (V_A) KIAS	- 15 -
3.4 NEVER EXCEED SPEED (V_{NE}) KIAS	- 15 -
3.5 CROSSWIND AND WIND LIMITATION	- 15 -
3.6 LANDING APPROACH SPEED	- 15 -
3.7 SERVICE CEILING	- 15 -
3.8 LOAD FACTORS	- 16 -
3.9 PROHIBITED MANOEUVERS	- 16 -
3.10 OTHER LIMITATIONS	- 16 -
4. WEIGHT AND BALANCE INFORMATION	- 17 -
4.1 CENTRE OF GRAVITY (CG) RANGE AND DETERMINATION	- 17 -
4.1.1 <i>Weight and balance determination for flight</i>	- 17 -
4.1.2 <i>Detailed calculation of CG position (applies to nose or tail wheel versions)</i>	- 17 -
5. PERFORMANCE	- 18 -
5.1 TAKE-OFF AND LANDING DISTANCES	- 18 -
5.2 RATE OF CLIMB	- 18 -
5.3 CRUISE SPEEDS	- 19 -
5.4 RPM	- 19 -
5.5 OTHER PERFORMANCE DATA	- 19 -
6. EMERGENCY PROCEDURES	- 20 -
6.1 INTRODUCTION	- 20 -
6.2 ENGINE FAILURE AND EMERGENCY LANDINGS	- 20 -
6.2.1 <i>Engine Failure during Take-Off Run</i>	- 20 -
6.2.2 <i>Engine Failure during Take-Off</i>	- 20 -
6.2.3 <i>In-flight Engine Failure</i>	- 20 -
6.2.4 <i>Additional information on engine failure and emergency landing procedures</i>	- 20 -
6.2.5 <i>Carburettor Icing (N/A 912iS Sport or 915iS)</i>	- 21 -
6.2.6 <i>In-flight Engine Starting</i>	- 21 -
6.3 FIRES	- 21 -
6.3.1 <i>Engine fire on the ground</i>	- 22 -
6.3.2 <i>Engine fire during takeoff</i>	- 22 -
6.3.3 <i>Engine fire in flight</i>	- 22 -
6.3.4 <i>Cockpit or electrical fire</i>	- 23 -
6.4 GLIDING	- 23 -
6.5 PRECAUTIONARY LANDING	- 23 -
6.6 BLOWN-OUT TYRE LANDING	- 23 -

6.7 DAMAGED LANDING GEAR LANDING	- 24 -
6.8 VIBRATIONS OR OTHER ENGINE PROBLEM	- 24 -
6.9 INADVERTENT ICING ENCOUNTERED (NOT 912IS AND 915IS)	- 24 -
6.10 EXTREME TURBULENCE ENCOUNTERED	- 24 -
6.11 ELECTRICAL SYSTEM MALFUNCTIONS	- 24 -
6.12 INADVERTENT STALL AND SPIN RECOVERY	- 24 -
7. NORMAL PROCEDURES	- 25 -
7.1 WING FOLD OPERATION AND DESCRIPTION	- 25 -
7.2 DESCRIPTION	- 25 -
7.3 WING FOLD FOR TRANSPORT	- 25 -
7.4 PRE-FLIGHT INSPECTION	- 27 -
7.4.1 Daily Preparation	- 27 -
7.4.2 Engine Warm-Up, Power Check	- 29 -
7.4.3 Pre-Flight Inspection	- 29 -
7.5 ENGINE STARTING 912UL/ULS (FOR 912IS SPORT AND 915IS STARTING, PARA 12.5)	- 29 -
7.5.1 Use of External Power Supply	- 29 -
7.5.2 Engine Starting	- 30 -
7.6 TAXIING	- 30 -
7.6.1 Prior to Taxiing	- 30 -
7.6.2 Taxiing	- 30 -
7.7 NORMAL TAKEOFF	- 31 -
7.7.1 Prior to Take-Off	- 31 -
7.7.2 Take-Off	- 31 -
7.8 BEST ANGLE OF CLIMB SPEED (V_x)	- 32 -
7.9 BEST RATE OF CLIMB SPEED (V_y)	- 32 -
7.10 CRUISE	- 32 -
7.11 APPROACH	- 32 -
7.11.1 Descent	- 32 -
7.11.2 Downwind	- 33 -
7.12 NORMAL LANDING	- 33 -
7.12.1 On Base Leg	- 33 -
7.12.2 On Final	- 33 -
7.12.3 Short Final	- 33 -
7.12.4 Landing	- 33 -
7.12.5 After landing	- 34 -
7.12.6 Engine Stopping	- 34 -
7.12.7 Post-Flight Check	- 34 -
7.13 SHORT FIELD TAKE-OFF AND LANDING PROCEDURES	- 34 -
7.14 BALKED LANDING PROCEDURES	- 34 -
7.15 INFORMATION ON STALLS, SPINS AND ANY OTHER USEFUL PILOT INFORMATION	- 35 -
7.15.1 Rain	- 35 -
8. AIRCRAFT GROUND HANDLING AND SERVICING	- 36 -
8.1 SERVICING FUEL, OIL, COOLANT	- 36 -
8.1.1 Servicing fuel	- 36 -
8.1.2 Servicing oil	- 36 -
8.1.3 Servicing coolant	- 36 -
8.2 LANDING GEAR TYRE DIMENSION AND PRESSURE GUIDE	- 36 -
8.3 GROUND HANDLING AND TIE-DOWN INSTRUCTIONS	- 37 -
8.3.1 Aircraft moving instruction	- 37 -
8.3.2 Aircraft tie-down instruction	- 37 -
9. PARACHUTE INSTALLATION	- 38 -
9.1 PARACHUTE OPERATING DATA AND PROCEDURES	- 38 -
9.2 MAINTENANCE REQUIREMENTS FOR CONTINUED SAFE OPERATION OF THE PARACHUTE	- 38 -
10. REQUIRED PLACARDS AND MARKINGS	- 39 -
10.1 AIRSPEED INDICATOR RANGE MARKINGS (THESE MUST BE MARKED ON THE ASI)	- 39 -
10.2 OVERVIEW OF SPEED LIMITS: (INDICATED AIRSPEEDS)	- 39 -
11. OPERATING LIMITATION PLACARDS IN SIGHT OF OCCUPANTS	- 40 -
11.1 "NO INTENTIONAL SPINS"	- 40 -
11.2 MISCELLANEOUS PLACARDS AND MARKINGS	- 40 -

11.3 EUROFOX AIRCRAFT PLACARDS - 41 -

12. SUPPLEMENTARY INFORMATION - 42 -

12.1 FAMILIARIZATION FLIGHT PROCEDURES - 42 -

12.2 PILOT OPERATING ADVISORIES - 42 -

12.3 FURTHER INFORMATION - 42 -

12.4 STARTING AND PRE-FLIGHT CHECKS 912UL AND 912ULS - 43 -

12.5 STARTING AND PRE-FLIGHT CHECKS LANDING AND SHUTDOWN PROCEDURE 912iS SPORT AND 915iS - 44 -

12.6 AUTOPILOT - 45 -

1. General information

1.1 Introduction

This handbook is provided with your aircraft to allow you to attain as much knowledge about the aircraft and its operation as possible. Read this manual thoroughly before your first flight and make sure you understand all the information contained here. This aircraft is equipped with a non-certified engine. When flying the aircraft always ensure that a safe landing would be possible in the event of loss of engine power. Pay attention to the fact that you as the pilot, are fully responsible for safety of your passengers and persons or property on the ground.

1.2 Certification Basis

This aircraft is a Type Approved Microlight and was manufactured in accordance with BCAR Section S airworthiness standards approved by the UK CAA. A certificate of conformance is supplied with each Type Approved Microlight.

1.3 Manufacturer

Ascent Industries Ltd T/A EUROFOX AVIATION

The Hangar

Wanshurstgreen Farm,

Battle lane,

Marden,

Kent, TN12 9DF

EuroFOX Aviation is a trading name of Ascent industries Ltd. Company registration nr 7731403

UK Distributor www.eurofoxaviation.co.uk

1.4 Warning, Caution and Note

In this handbook the following is used to highlight especially important information:

WARNING	Information which could prevent personnel injury or loss of life
CAUTION	Information which could prevent damage to equipment
NOTE	<i>Information of special importance to pilots</i>

2. Aircraft and Systems Description

2.1 Nose wheel

(Note: All versions have the swept forward wings that are shown in the tail dragger drawing)

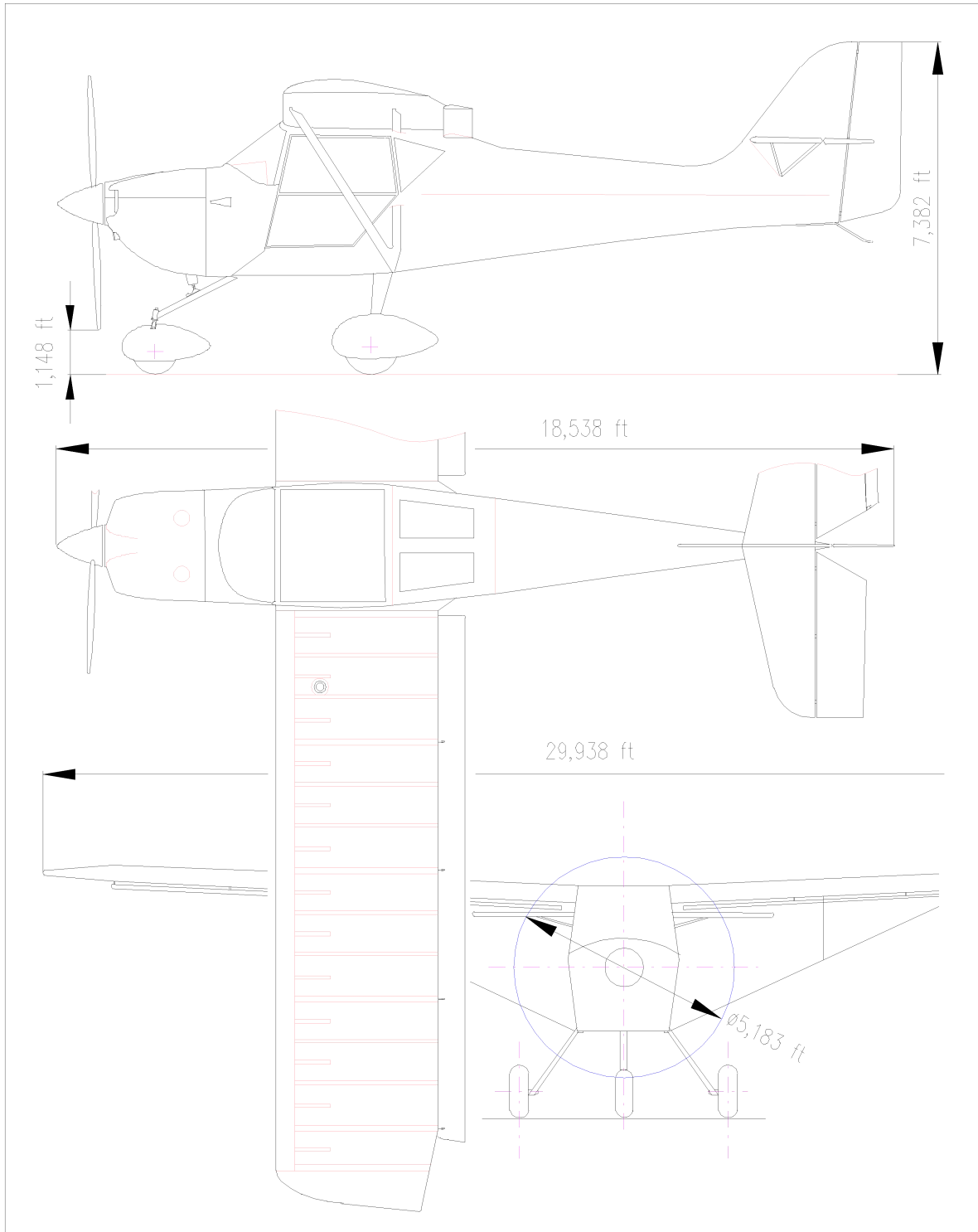

2.2 Tail wheel

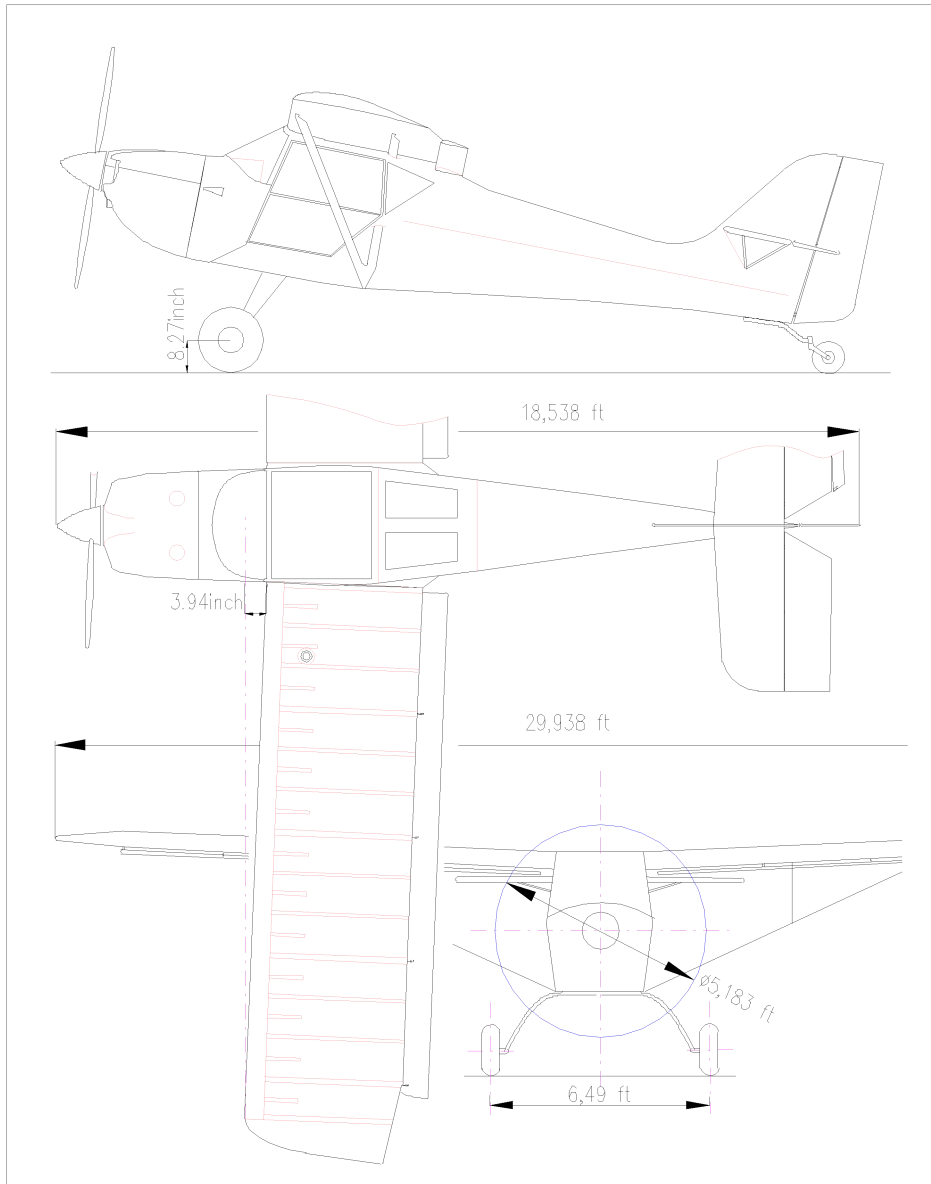

The EuroFOX is designed as a high-wing monoplane. A two-spar wing is equipped with flapperons. The fuselage is an open truss structure welded with steel tubes. The tail unit is formed from a lattice-work tube frame. The Aircraft is equipped with tricycle or conventional landing gear and incorporates a steerable nose or tail wheel.

Wing span.....	9,125 m
Length.....	5,65 m
Height.....	2,25 m
Wing area with flap.....	11,4 m ²
Chord length without flap.....	1,12 m
with flap.....	1,3 m
Wing loading 560 kgs MAUW.....	49.1 kgm ⁻²
Aspect-ratio.....	7,3
Propeller clearance (Minimum).....	0,300 m

2.3 Engine

The EuroFOX is powered by Rotax 912UL (80hp) ROTAX 912 ULS (100HP) 912iS Sport (100HP) or Rotax 915iS (141hp) engine – **NOTE** only the “01” engine variants, modified for coolant temperature measurement as opposed to the previous cylinder head temperature measurement are permitted to be installed. Any reference in this manual to a Rotax 912 refers to the “01” engine variants only.

It is a four-cylinder, four-stroke, horizontally opposed-cylinder, centre-camshaft engine with over-head valves. Engine cooling is of a combined type, cylinder heads are water-cooled, while cylinders are air-cooled. The engine has dry sump lubrication. The ignition system is of a dual, distributor less and capacitor flywheel magneto type. The engine is equipped with an electric starter, AC generator and a mechanical fuel delivery pump, with optional additional electric pump. The propeller is powered from an integrated reduction gear with mechanical damping.

Engine manufacturer.....ROTAX GmbH., Austria

Engine model Rotax 912UL (80hp) ROTAX 912 ULS (100HP) 912iS Sport (100HP) or Rotax 915iS (141hp) engine variants only

For all engine information and limitations please refer to the Rotax operators manual as issued with the EuroFOX Type Approved Microlight. As the aircraft owner, you are responsible for applying any Rotax updates or bulletins issued by Rotax.

WARNING

This engine is not certified and it may fail at any time

2.4 UK approved propellers for use with your Type Approved Microlight

All are 3 blade props unless stated. DUC Swirl “R” design 1660mm for Rotax 912UL, Rotax 912ULS (100hp) or Rotax 912iS Sport (100hp) DUC Swirl (1730mm dia) and Woodcomp AE174 are the approved propeller types and specifications. Duc Flash 3 (4 blade) 1850mm (tail wheel) 1750mm (Nose wheel) for Rotax 915iS

For additional propeller information see **Operators Manual and Technical description** supplied with the propeller in your Type Approved Microlight. DUC props need mandatory factory inspection at 2000 hours, and a recommended inspection at 5 years (can be conduction via zoom etc)

2.5 Fuel and fuel capacity

Fuel tank capacity - wing tanks.....2x 40 litres

- central connecting tank.....6 litres

Max. fuel quantity.....86 litres

Usable fuel quantity.....85 litres

Unusable fuel quantity......1 litre

Fuel specification EN228 min RON 90 RON 95 (912UL, 912ULS, 912iS, 915iS) super unleaded Mogas fuel (Standard Spec. for Automotive Spark-Ignition Engine) or AVGAS 100 LL.

Due to the higher lead content in AVGAS, the deposits in the combustion chamber and lead sediments in the lubrication system will cause an increase in the wear of the valve seats. Therefore, use AVGAS only if you encounter problems with vapour lock or if other fuel types are not available.

For additional information concerning fuel specification consult **Operator’s Manual for all versions of Rotax 912/915** supplied with the engine and the most recent updates as issued by Rotax.

The fuel system includes two wing tanks of 40 litres each, a central tank of 6 litres, Fuel drain valve, fuel valves, a fuel filter, an engine fuel pump and connecting lines. Fuel tanks and fuel lines are suitable for fuel containing ethanol.

The fuel is gravity-fed from the right-hand or left-hand wing tank into the 6L central tank depending on which wing tank fuel valve is open. The fuel is then further directed from the central tank via the main fuel valve and fuel filter into the mechanical fuel pump on the engine which delivers the fuel to the carburettors. (additional electric fuel pump optional)

The amount of fuel in each tank is indicated by a wing root visual fuel gauge which is a part of each tank. Minimum fuel quantity in the central feeder tank is indicated by a warning light on the instrument panel. When remaining fuel is 4,1 litres, the light will illuminate and this means enough fuel for approximately 10-15 minutes of flight. The warning light condition can be verified at any time by pushing the control button. No red light indication when the control button is pushed and held means the bulb is blown out and the minimum fuel quantity is not indicated:- In this case, make a more conservative estimate for fuel on board, check fuel quantity in wing tanks and land as soon as you are not confident of the fuel quantity inside the wing tanks. Optionally, an EuroFOX Aviation back up fuel pump is available.

Do not forget to properly open and manage the main fuel tank valves to ensure continuous flow of fuel to the engine. **Both fuel tanks should be open and used at all times, thus feeding the header tank in normal flight.** A single

tank can be shut off if required (suspected contamination for example) without affecting the aircraft operation, but of course the range will be reduced.

The fuel drain valve outlet is behind the left seat on the outside bottom side of the fuselage; to drain off water and dirt, the drain pipe is to be pressed into the fuselage and subsequently a fuel sample is to be taken.

For refuelling information see section 8.1

2.6 Oil

Oil tank capacity.....	3.2 litres
Maximum oil quantity.....	2.6 litres
Minimum oil quantity.....	2.1 litres

Oil specification:

When selecting the most suitable lubricants refer to the latest recommendations issued by Rotax and/or it's UK distributor.

- Use only oil as recommended by Rotax or its distributor

CAUTION: If the engine is mainly run on AVGAS **more frequent** oil changes will be required. See the latest Rotax Service and maintenance Information required for running on avgas.

For additional information concerning oil system consult **Operator's Manual for all versions of Rotax 912/915** supplied with the engine, with supplements as issued periodically by Rotax.

The maximum and minimum oil level is indicated by two marks on the dip stick in the oil tank.

2.7 Oil Warming Flap

The EuroFOX is fitted with an adjustable aluminium flap that when operated (knob on panel pulled out), will blank off all air going to the oil cooling radiator. This enable rapid warming of the oil at first start and in colder conditions, adjustment of this flap will enable the pilot to keep the oil temperature in the green operating arc in the gauge. Care should be taken when the flap is closed and the air blocked off, that the oil temperature does not rise outside placarded limits. This is only likely to happen in very hot weather or continual high power work e.g multiple circuits. **Note This flap is not available for the 915iS**

2.8 Operating weights and loading (occupants, baggage, fuel, ballast)

Max basic empty weight for 912UL and 912iS - 560kg-200kg- 1 hr fuel at max con't (18kg) 342 kg

Max Basic empty weight for 912ULS 560kg-200kg- 1 hr fuel (19kg) 341 kg

Max Basic empty weight for 915iS 560kg-200kg- 1 hr fuel (30kg) 330 kg

Max. take-off weight.....	560 kg
Max. landing weight.....	560 kg
Max. fuel weight.....	61 kg
Max. baggage weight in baggage compartment.....	18 kg
Max. baggage weight in baggage compartment with Winch or Parachute	8 kg

2.9 Crew

Number of seats 2

Minimum crew weight.....55 kg

Max crew weight per seat 83 kg (Note: occupant limit is 100kgs per seat or 200kgs for the seat pan)



Make sure that above mentioned weight limits are strictly followed.

Structural failures which result from overloading of the aircraft may be dramatic and catastrophic.

The additional stress placed on the structural parts by overloading can accelerate the occurrence of metal fatigue failures. Also flight characteristics might change significantly when the aircraft is overloaded. Takeoff and landing distance are significantly longer for overloaded aircraft. Overloading and out of balance loading of the aircraft is one of the most common causes of accidents.

2.10 Cabin overview (guide only)

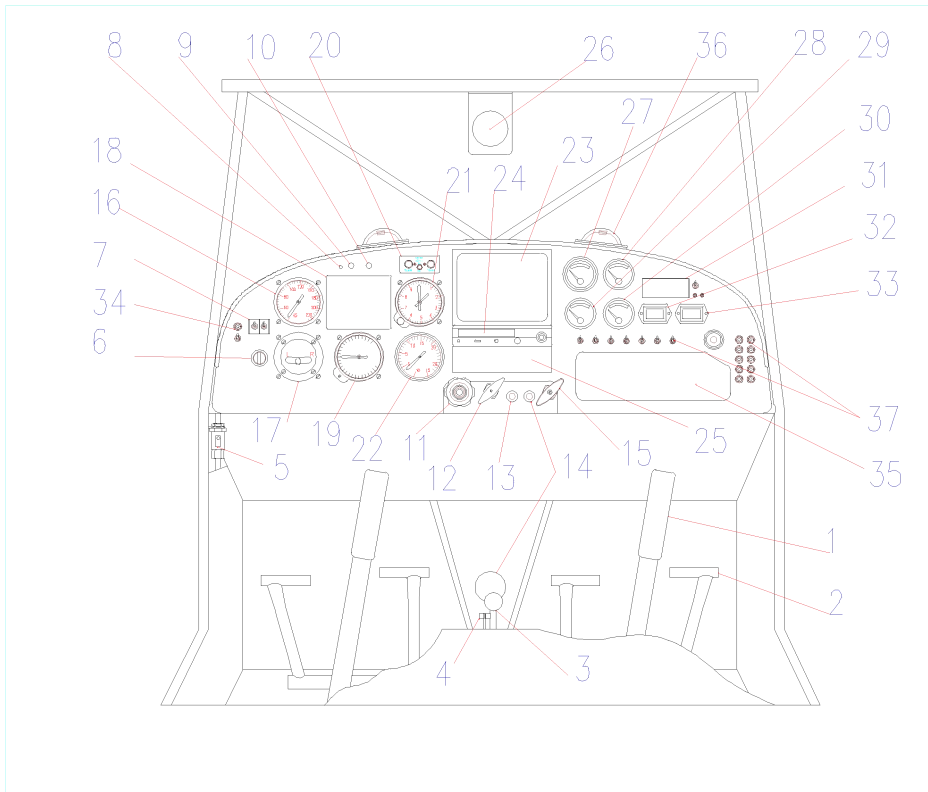

TYPICAL LAYOUT OF THE PANEL CONTROLS AND INSTRUMENTS

(see following pages for details, however the Type Approved Microlight has freedom to organise the panel to his or her wishes – this is only a guide as each aircraft will be different)

- | | | |
|-------------------------------|----------------------------|------------------------------------|
| 1. Control stick | 15. Choke | 30. Fuel pressure gauge |
| 2. Rudder pedals | 16. ASI | 31. Outside temperature. |
| 3. Wing flaps | 17. Slip Ball indicator | 32. Flight hours gauge |
| 4. Trim elevator | 18. EFIS – D6 or D10 | 33. Engine hour gauge |
| 5. Fuel cock | 19. VSI | 34. Switch for Electric fuel pump. |
| 6. Master Switch | 20. INTERCOM | 35. Compartment for maps |
| 7. Ignition | 21. Altimeter | 36. Ventilation |
| 8. Min. fuel pushbutton | 22. RPM indicator | 37. Switch + circuit breakers |
| 9. Last 4 liter warning light | 23. GPS | 37.1 Landing light |
| 10. Charging light | 24. Radio | 37.2 Strobe light |
| 11. Throttle control lever | 25. Transponder | 37.3 Gyro or EFIS |
| 12. Brake with park brake | 26. Magnetic Compass | 37.4 Free |
| 13. Carb heat. | 27. Oil temperature | 37.5 Radio |
| 14. Heater | 28. Oil pressure gauge | 37.6 Transponder |
| | 29. Head temperature gauge | 37.7 GPS |

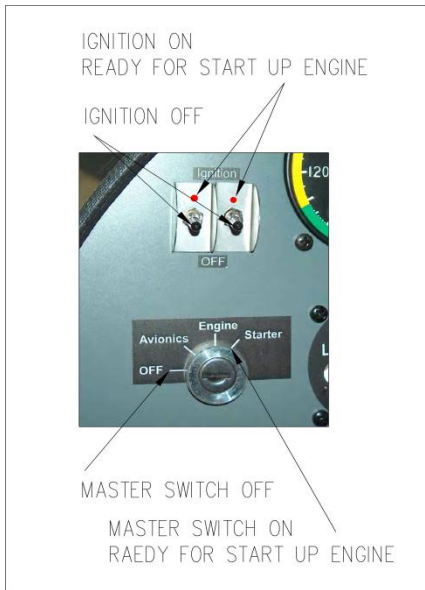

Ignition and master switch

Main Fuel Valve open and close position

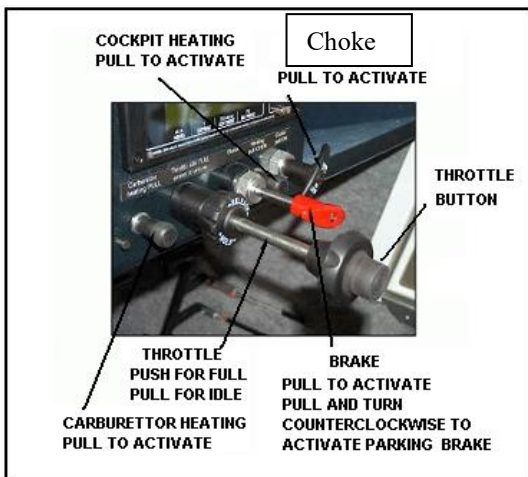
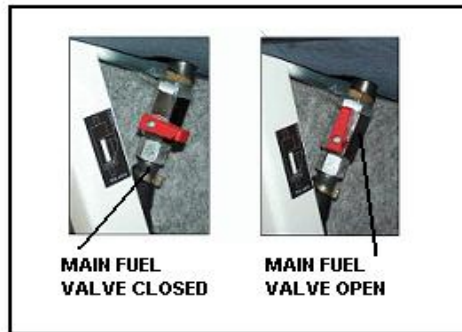

Central panel (typical overview)

Note: A simple friction throttle is supplied for UK Type Approved Microlights

Aircraft
firewall

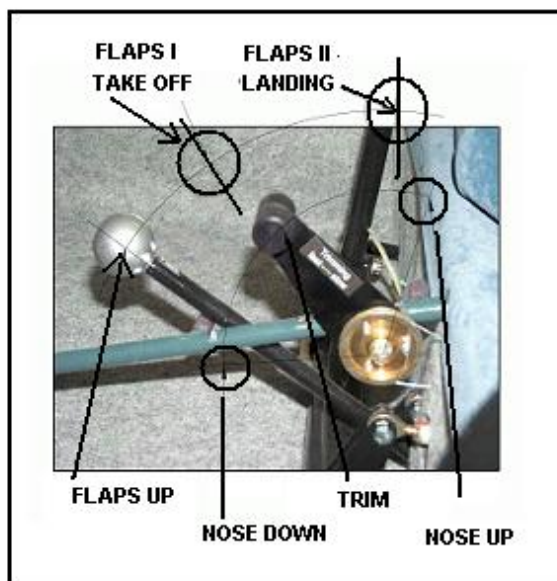

Pilot
seat side

Intuitive flap and trim levers located between P1 and P2 seat position



Example of switch and fuse layout



Warning lights and fuel reserve bulb check button



Door locking mechanism. Note: The door handle needs to be turned to close door as well as open door

The battery is typically a lightweight lithium iron phosphate (LiFePO₄), a starter battery with high cranking abilities and is located behind the right-hand pilot's seat. Nominal voltage in aircraft system is 13.5 to 14.2 V. The engine is equipped with integrated AC generator with external rectifier-regulator (12 V, 20A DC). The battery has its own internal fully integrated battery management system, but is further isolated from the aircraft systems with a pullable 30a circuit breaker. Any Lithium battery must have a battery management system in line with the Rotax requirements.

Type	Lithium or Gel	
Voltage	12 V	
Capacity	340 cranking amps, 6 amp hours	

2.11 CO Monitoring patch

As the EuroFOX uses hot air from around the silencer via a heat exchanger and ducting, it is mandatory that a CO detector with an electronic monitor with audible warning is fitted within sight of the pilot and in the cabin area.

If the monitor is activated owner should investigate as to why and the exhaust system and cabin heat system checked.

2.12 Autopilot

Supplementary instructions for an optional autopilot system are given in Section 12.6.

3. Operating limitations

All flight speeds in this POH are presented in Knots indicated airspeed (KIAS) using an approved calibration table for Type Approved EuroFOX. The static tube reference point is inside the cabin behind the panel.

3.1 Stall speed at maximum take-off weight (V_S and V_{SO})

Aircraft configuration	Stall speed KIAS – angle of bank 0°	
		KIAS
Flaps down (V_{SO})		38
Flaps up (V_S)		43
Loss of height in stall	50-100 ft	



The stall speed mentioned above are with wings level. Once any angle of bank (e.g. turn) is encountered the stall speed is significantly increased.

Max angle of bank – 60°

The more bank – the higher stall speed. This simple rule is especially important when a turn at maximum permitted angle of bank (60°) is performed. Do not start the turn until you have sufficient airspeed reserve. Full throttle is also essential to have sufficient thrust in reserve as the drag is increased during a steep turn.

3.2 Flaps extended speed range (V_{SO} to V_{FE}) KIAS

		KIAS
Lower limit		38
Upper limit		83

3.3 Maximum manoeuvring speed (V_A) KIAS

		KIAS
Max. manoeuvring speed (V_A)		90

Full control deflections may only be used up to V_A . Above V_A control deflections must be restricted to 1/3 full deflection. V_A is also the maximum speed for flight in turbulent air.

3.4 Never exceed speed (V_{NE}) KIAS

		KIAS
Never exceed speed (V_{NE})		135

3.5 Crosswind and wind limitation

Crosswind.....tail wheel 12 Kts.....nosewheel 15kts

tail wind..... 4kts

Cross wind take off and landings require training and experience, the higher the crosswind component, the better your skill must be. Do not fly without proper experience when the wind speed is approaching the limit. Avoid take offs with tail wind when possible – the total take off distance is significantly longer and longer ground distance is required to gain altitude.

When landing with tail wind the aircraft ground speed is higher resulting in a longer landing distance.

3.6 Landing approach speed

Both nose and tail wheel versions.....50-55 KIAS (45 KIAS at the threshold)

3.7 Service ceiling

Ceiling..... 14 760 ft

WARNING

Oxygen mask and/or other equipment required to reach maximum ceiling, consult respective regulations.

3.8 Load factors

Flaps up:

Maximum positive centre of gravity load factor.....+ 4 Gs

Maximum negative centre of gravity load factor.....- 1.5 Gs

Flaps down:

Maximum positive centre of gravity load factor.....+ 4 Gs

Maximum negative centre of gravity load factor.....-1.5 Gs

3.9 Prohibited manoeuvres**WARNING**

**Aerobatics and intentional spins are prohibited.
Maximum angle of bank, port and Starboard: 60°
Maximum angle of pitch up and down: 45°**

3.10 Other Limitations**WARNING**

No smoking

WARNING

Flights with rear "turtle deck" canopy removed are prohibited

WARNING

**Only VFR day flights at ambient temperature above -10 C are permitted.
Flights at ambient temperature between -10 C and 0 C are permitted only under no icing conditions and when the carburettor heating is activated (if fitted).**

WARNING

**IFR flights and flying in cloud is prohibited.
Flight into known icing conditions is prohibited**

This aircraft is not certified for operation in IMC (Instrument meteorological conditions). Always stay clear of clouds and have visual contact with the ground. Follow the airspace classification regarding distance from clouds.

Always evaluate the weather during your flight and try to get weather information from your destination using the radio whenever possible. When weather is deteriorating make a diversion or turn back before low cloud base and/or low visibility are outside local licence requirements.

4. Weight and Balance Information

4.1 Centre of gravity (CG) range and determination

Aircraft handling and performance have been determined for this range of CG positions.

Centre of gravity limits	Front limit (mm)	Rear limit (mm)
For all engine versions	260	425

The CG position of the dry empty aircraft is determined by weighing. The procedure is described in the Maintenance manual. The whole procedure must be repeated and new **Aircraft weight and balance statement** be prepared whenever a modification or repair having an impact on the weight of the aircraft occurs.

Each EuroFOX Type approved microlight will be issued with a factory produced weighing and CG report

Weighing attitude: The aircraft longerons on the base of the entry doors, must be level 0 degrees

4.1.1 Weight and balance determination for flight

WARNING

The aircraft must not be operated outside of its approved weight and balance limitations to assure safe flying.

Providing that the pilot does not load the aircraft outside the placarded weights, then the aircraft will always be inside the aircraft CG range.

It is imperative that the pilot knows exactly the real empty weight of his or her aircraft.

4.1.2 Detailed calculation of CG position (applies to nose or tail wheel versions)

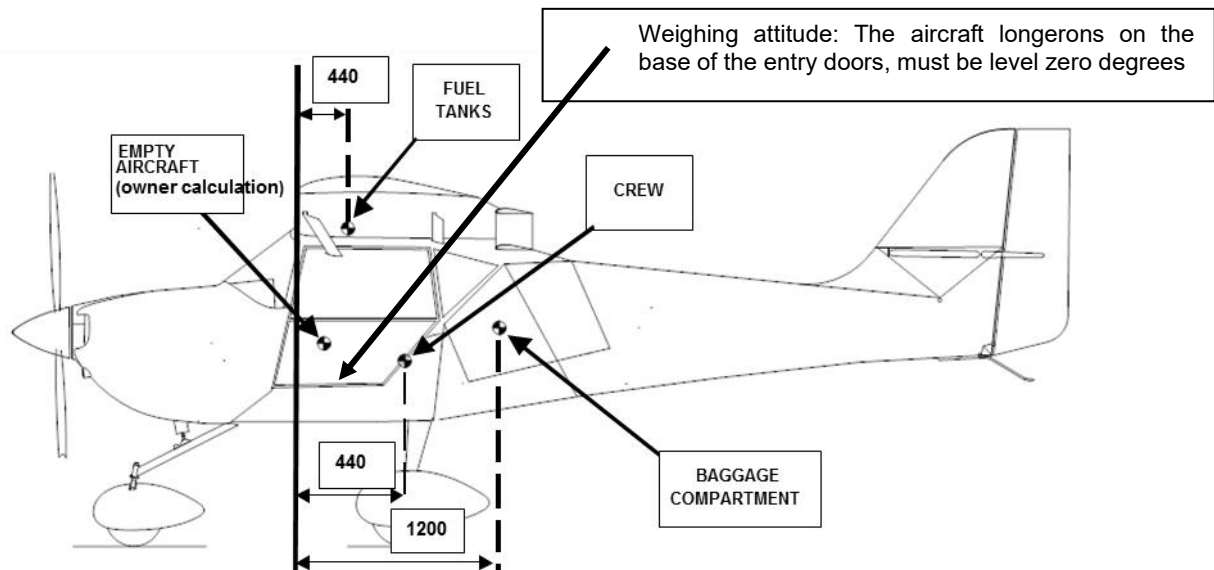

As all reference points are located behind the leading edge of the wing at the root, the leading edge was selected as the reference plane. The table below shows a typical calculation including an example.

The datum point (50 mm forward of the wing leading edge at the root) to wheel centre line distances on all EuroFOX aircraft are as follows: (these figures take into account the wing forward sweep of 50)

Nose wheel:

- From datum point to nose wheel centre line = - 919 mm
- From datum point to main wheel centre line = 503 mm

Tail wheel

- From datum point to main wheel centre line = - 21 mm
- From datum point to tail wheel centre line = 4289 mm

These measurement values are to be used to calculate the weight and balance

5. Performance

The data is based on particular flight measurements undertaken with the aircraft of this type in good service conditions and with application of average piloting skills. The performance stated below are calculated at sea level of the international standard atmosphere (ISA). Variations in pilot technique can cause significant differences as well as the other conditions like runway slope, runway surface condition, humidity etc.

Use the following data for guidance but do not plan a take-off or landing when only 50 ft extra runway length is available or do not plan a cross country with only 8 litres of fuel expected to remain when arriving at your destination. Always be conservative when planning a flight and be ready for the unexpected – unexpected wind, atmospheric turbulence or sudden weather change at the destination forcing you to divert to airfield 60 NM away. Always plan a reasonable fuel reserve – 60 minutes seems to be sufficient time for most of flights, but this time should be increased when complicated weather conditions (strong headwind or rain showers) are expected en route.

The propeller installed on your aircraft was set to achieve the best compromise between take off and cruising performance (the performance information below are based on this setting).

The propeller pitch may not be changed without formal approval. Contact EuroFOX Aviation for details.

Always be carefully when making this change and make a record of the current settings. When the propeller is set to achieve a maximum cruise speed, the take-off distance is significantly longer.

On the other hand, when the propeller is set to achieve good rate of climb, the fuel consumption during level flight is higher. When a finer pitch is set (e.g. climb setting), a higher static RPM is achieved when aircraft is static and full power is applied. Be careful not to exceed the Rotax maximum limit RPM.

5.1 Take-off and landing distances

Surface	Take off Distance (Metres)	
	Ground run	Take off distance to 50 ft
Grass runway 80HP 912UL	160 max	360
Grass Runway 100 HP 912ULS or 912iS Sport	150 max	325
Grass runway 141HP 915iS	110 max	260

Surface	Landing Distance (Metres)	
	Landing distance from 50 ft	Ground run
Grass runway (all engine types)	350	170

Both take-off and landing distance are significantly increased by the following factors:

- Tail wind
- High airport altitude and high air temperature
- Up-hill runway slope
- Runway wet or covered with snow, dust or water
- Propeller set to achieve better cruising performance

5.2 Rate of climb

	912UL	912ULS or 912iS Sport	915iS
Rate of climb (fpm)	700	900	1500
Best climb angle speed (V _x)	55 KIAS	55 KIAS	60 KIAS
Best climb rate speed (V _y)	65 KIAS	65 KIAS	65 KIAS

For the 915iS, it is recommended that for the best view over the nose that 70KIAS is used, except when aerotowing as the rate of climb is reduced.

5.3 Cruise speeds

VA should not be exceeded in rough air.

5.4 RPM

Max. take off power..... 5,800 (5 mins)

Max. continuous power..... 5,500

Idle speed Min.....approx. 1,600rpm (2000rpm for 912iS and 915iS)

EuroFOX with 80hp Rotax engine, using the DUC Swirl 1660 mm diameter propeller has a pitch setting of 21 degrees at 210mm from tip to give 5000-5100 rpm during ground roll.

EuroFOX with 100hp Rotax engine, using the DUC Swirl 1730 mm diameter propeller has a pitch setting of 25 degrees at 210mm from tip to give 5150 rpm during ground roll.

EuroFOX with 100hp Rotax engine, using the Woodcomp AE174 propeller has a pitch setting of 27 degrees at 370mm from tip to give 5050 rpm during ground roll.

EuroFOX 2K with 140hp Rotax engine, using the DUC Flash 1850mm diameter propeller has a pitch setting of 24 degrees at 250mm from tip to give 5300 rpm during ground roll

EuroFOX 3K with 140hp Rotax engine, using the DUC Flash 1750mm diameter propeller has a pitch setting of 25 degrees at 250mm from tip to give 5300 rpm during ground roll

The Rotax max rpm figures for the engine (5500rpm continuous and 5800rpm for 5 mins max) are the limits for the engine.

Fuel consumption during cruise flight is dependent on various factors. The most important ones are engine settings and propeller settings. The propeller settings cannot be changed in flight, but the higher the engine RPM is set during cruise, the higher the fuel consumption.

When planning a flight, always consider your rpm setting and other factors like wind direction and speed or expected weather en route. Always plan for sufficient fuel reserve when arriving at the destination. Always carefully evaluate fuel consumption during the flight.

5.5 Other performance data

Max. endurance.....6 hours (5 hours 915iS)

Max. range..... 620 Statute miles

Max. speed flying with doors open..... 60 KIAS

6. Emergency procedures

6.1 Introduction

This section contains procedures for various emergencies which may occur. Emergencies caused by aircraft or engine malfunctions are rare if proper pre-flight inspections and maintenance are practised.

The chapter describes basic emergencies and recovery procedures. Not all emergencies that may occur can be listed here in full, therefore their solution depends on the experience of the crew controlling course of such events. All air speed values in this chapter are presented in KIAS, as this value represents instrument reading better than the Calibrated air speed. In respect to any engine failure, first priority is always FLY THE AIRCRAFT.

6.2 Engine Failure and Emergency landings

6.2.1 Engine Failure during Take-Off Run

- throttle REDUCE TO IDLE
- ignition OFF
- master switch OFF
- brakes AS REQUIRED

6.2.2 Engine Failure during Take-Off

- airspeed 60-65 KIAS
- choice of landing site - after take-off and up to a height of 500 ft - land in straight direction ahead, if possible
- over 500 ft choose suitable landing site

The landing site is to be preferably chosen in the runway direction or the nearest suitable site clear of obstacles

- master switch OFF
- ignition OFF
- main fuel valve SHUT
- tank fuel valves SHUT
- flaps EXTEND AS NEEDED
- safety belts TIGHTEN

after touchdown:

- brakes AS REQUIRED

6.2.3 In-flight Engine Failure

- airspeed 55-60 KIAS
- landing site selection SELECT
- transmit MAYDAY on 121,5, ELT ON, XPDR 7700 - if time permits

- check
- master switch ON
 - ignition ON
 - main fuel valve OPEN
 - wing tank fuel valves OPEN to tank with more fuel
 - Electric fuel pump (s) ON
 - throttle SET TO 1/3 OF TRAVEL
 - starter START THE ENGINE

If the engine cannot be restarted, proceed in accordance with the procedure 6.2.2 .

6.2.4 Additional information on engine failure and emergency landing procedures

If the engine failure occurs during the take-off run, the pilots main concern should be to stop the aircraft on the remaining runway. Those extra items in the checklist are to add protection should the runway be too short to stop.

In flight, prompt reduction of pitch attitude to obtain and maintain a proper glide speed upon experiencing an engine failure is the first priority. If the failure has occurred shortly after take-off, a landing should be planned straight ahead

with only small changes in the flight direction to avoid obstacles. The best gliding ratio can be achieved with flaps up – flaps down will reduce the stall speed but at the same time deteriorating gliding performance. Try to stop rotation of propeller if restarting efforts are not successful – wind milling propeller has a higher drag than stopped propeller.

While gliding towards a selected forced landing site, an effort should be made to determine and correct the cause of engine failure – time and altitude permitting. Do not concentrate on cause determination or restart effort unless you have selected a suitable landing site and you are confident of this manoeuvre. Flying the aircraft (especially maintaining the proper gliding speed) is always the first priority. If the cause cannot be determined and corrected the emergency landing must be accomplished.

Always announce your intent and position after engine failure using radio and other equipment when time permits. Turn radio to international emergency frequency – 121.5 and transmit MAYDAY message. Activate Emergency locator transmitter (ELBA) – set the switch to ON position. Set transponder (XPDR) to emergency code 7700. When the above mentioned procedure cannot be performed due to time constraints try to complete as many steps as possible. Transmitting MAYDAY message on the frequency already tuned on your radio should be the minimum procedure.

WARNING

During a landing it is vital for the pilot to continue to fly the aircraft. Damages and/or injuries can be minimised if the pilot is fully concentrating on controlling the aircraft until it comes to complete stop

6.2.5 Carburettor Icing (N/A 912iS Sport or 915iS)

Carburettor icing mostly occurs when getting into an area of ice formation. The carburettor icing shows itself through a decrease in engine power and an increase in engine temperatures. To recover the engine power, the following procedure is recommended:

- carburettors heating ACTIVATE
- airspeed 65 KIAS
- throttle 1/3 of power \approx (3500 RPM)
- if possible, leave the icing area
- gradually increase the engine power to cruise conditions after 1-2 minutes
- if you fail to recover the engine power, land at the nearest airfield (if feasible), or, depending on circumstance, off-airfield, following the procedure given under 6.2.2

6.2.6 In-flight Engine Starting

- airspeed 65 KIAS
- landing site selection SELECT
- master switch ON
- main fuel valve OPEN
- wing tank fuel valves OPEN to tank with more fuel
- Electric fuel pump (s) ON
- choke SWITCH ON (cold engine only) (not 912iS and 915iS)
- throttle - ADJUST to 1/3 of travel
- IDLE (when choke is activated)
- ignition ON
- starter START UP
- if the engine cannot be restarted, increase the airspeed to 80 KIAS so that air flow can rotate the propeller, thus enabling engine starting. Don't spend too long trying to restart, if you see a good out landing field, take it immediately

WARNING

Loss of height needed for in-flight engine starting is about 500 to 650 ft.

6.3 Fires

Follow these procedure when fire or smoke in the engine compartment or cockpit is detected. Fires are extremely rare in properly maintained aircraft.

6.3.1 Engine fire on the ground

- main fuel valve SHUT
- tank fuel valves SHUT
- Brakes APPLY
- throttle FULL
- ignition switch off when engine has stopped as all remaining fuel in carburettors was burned
- Electric fuel pump (s) OFF
- master switch OFF
- abandon the aircraft and extinguish fire (if possible)
- Fire damage INSPECT

NOTE

Time needed to burn fuel remaining in carburettors after fuel valves are closed is around 30 sec.

WARNING

DO NOT CONDUCT ANOTHER FLIGHT BEFORE THE FIRE CAUSE HAS BEEN DETERMINED AND REPAIRED BY AUTHORISED PERSONNEL

6.3.2 Engine fire during takeoff

- throttle IDLE
- main fuel valve SHUT
- tank fuel valves SHUT
- Electric fuel pump (s) OFF
- airspeed 60-65 KIAS
- brakes STOP
- throttle FULL
- ignition switch off when engine has stopped as all remaining fuel in carburettors has burned
- abandon the aircraft and extinguish fire (if possible) once the aircraft is stopped

6.3.3 Engine fire in flight

- main fuel valve SHUT
- tank fuel valves SHUT
- Electric fuel pump (s) OFF
- throttle FULL
- airspeed INCREASE as required to find an airspeed which will provide an incombustible mixture. Do not exceed V_{NE}
- landing site selection guide the aircraft to the nearest airfield, or choose a suitable landing site for emergency landing
- ignition switch off when engine has stopped as all remaining fuel in carburettors was burned
- master switch OFF
- airspeed 55-60 KIAS
- wings flaps EXTEND AS NEEDED
- safety belts TIGHTEN
- perform emergency landing
- abandon the aircraft and extinguish fire (if possible)

WARNING

DO NOT ATTEMPT TO RESTART THE ENGINE

WARNING

DO NOT CONDUCT ANOTHER FLIGHT BEFORE THE FIRE CAUSE HAS BEEN DETERMINED AND REPAIRED BY AUTHORISED PERSONNEL

6.3.4 Cockpit or electrical fire

Electrical fires are usually signalled by the odour of burning insulation.

- cockpit door OPEN to remove smoke from the cockpit
- avionics and other switches OFF (except electric fuel pumps (912iS and 915iS))

Land at the nearest suitable landing site. Consider shutting down the engine (and master switch) once the suitable landing site is reached. Extinguish fire as soon as possible.

6.4 Gliding

- gliding ratio..... .9 : 1
- optimum gliding speed..... .55 KIAS
- rate of descent..... .700 fpm

Always consider flying though areas of descending air when calculating gliding range. Do not forget to have and maintain sufficient altitude to perform a landing procedure once suitable landing site has been reached.

6.5 Precautionary Landing

- choose suitable landing site, evaluate wind direction and speed, surface, surrounding obstacles and total safety of the manoeuvre under consideration
- perform approach and fly-over at a speed of 60-70 KIAS along the selected landing site at a height of 150 ft to estimate the area condition, obstacles and to determine exact landing direction
- Follow normal landings checklist and land

after touchdown

- Ignition OFF
- master switch OFF
- Electric fuel pump (s) OFF
- fuel valves SHUT
- brakes AS REQUIRED

A precautionary landing is preferable to an emergency landing. When engine vibration or engine roughness is presented, do not wait until the engine stops, perform a precautionary landing as soon as possible.

A precautionary landing is also used when the fuel exhaustion is imminent. This should not happen when proper flight preparation is performed. Always perform a precautionary landing before all fuel is consumed, emergency landing following the loss of power is more complicated and more risky.

Also consider a precautionary landing when bad weather is encountered. Again, it should not happen when proper flight planning is made. When the cloud base is forcing you to fly in low altitude and/or visibility is limited, try to fly a 180 course to avoid bad weather area. If the conditions are not getting better or even are deteriorating, perform a precautionary landing before the conditions become even worse.

6.6 Blown-Out Tyre Landing

- carry out normal approach-to-land
- when flaring at landing, keep the damaged wheel above ground as long as possible using ailerons (or elevator for the nose wheel)
- maintain the direction at landing run, applying rudder

6.7 Damaged Landing Gear Landing

- carry out a normal approach-to-land
- if the nose wheel is damaged, perform a touch-down on main wheels and hold the aircraft nose wheel up as long as possible till the speed is lost.
- if the main landing gear is damaged, perform touch-down at the lowest speed possible and maintain direction at landing run, if possible

6.8 Vibrations or other engine problem

If any forced vibrations appear in the aircraft, it is necessary:

- to set engine speed to such power rating where the vibrations are the lowest
- to land on the nearest airfield, or to perform a precautionary landing off-airfield
- if the vibrations are increasing, carry out an emergency landing off-airfield, following procedures given under 6.2.2

If the oil pressure reduces during a flight, an engine failure is probable. Reduce the engine power and execute a nearest airfield or precautionary landing before the engine failure occurs.

6.9 Inadvertent icing encountered (not 912iS and 915iS)

- carburettor heating ACTIVATE (if fitted)
- throttle INCREASE above normal cruise settings
- course REVERSE or ALTER as required to avoid icing

WARNING

**EVASIVE ACTION SHOULD BE INITIATED IMMEDIATELY
WHEN ICING CONDITIONS ARE ENCOUNTERED**

A prompt action must be taken immediately once icing conditions are encountered. A 180° turn and a climb is usually appropriate. If the airframe ice builds extremely rapidly, consider off-airport forced landing. Approach speed should be increased slightly depending upon icing severity.

6.10 Extreme turbulence encountered

- Airspeed REDUCE to VA
- safety belts SECURED
- loose objects SECURED

When an area of extreme turbulence is entered reduce airspeed to VA. Do not reduce the airspeed too low in order to prevent the aircraft from stalling due to turbulence. Do not increase the speed as this could cause structural damage to the aircraft.

6.11 Electrical system malfunctions

Charging indicating light is illuminated

When the red charging light is illuminated no immediate action is required. All avionics and other equipment are powered from the battery, so the power source is limited. Try to switch off instruments which are not necessary for flight and land at the nearest airfield

6.12 Inadvertent Stall and spin recovery

Spins should not occur during normal aircraft operation and they are prohibited.

The following general procedure should be followed should a stall occur:

- lower the nose by pushing the control stick
- gradually increase power

The following general procedure should be followed should a spin occurs:

- throttle IDLE
- rudder Neutral
- control stick Neutral

Once the rotation is stopped, establish a level flight.

7. Normal procedures

7.1 Wing Fold operation and description

7.2 Description

The rectangular-plan wing is of a metal frame structure. It is composed of two duralumin carrying tubes and a system of duralumin ribs and diagonal stiffeners. The duralumin rib system comprises of 14 full ribs and 13 false ribs, stiffening the skin in the leading-edge area of assembly. The horizontal plane section of the wing is strengthened with a system of steel diagonal tubular stiffeners. There is a 40 litre fuel tank built in the wing root section which is welded of aluminium alloy metal sheet. Correct shape of the wing leading edge is guaranteed due to a fiberglass die-formed shell glued on the leading edge tube. The trailing edge is formed of a duralumin shaped piece. The wing is fabric-covered.

Below the wing trailing edge are the flapperons incorporating both function of ailerons and wing flaps; they are attached to the rib ends by means of five hinges. The flapperon structure consists of a duralumin load-carrying tube swinging in the hinges and a fiberglass sandwich part, itself an inversely moulded aerofoil.

The wings are attached to the fuselage by wing struts which are load-carrying tubes attached to the underside section of the wing and the side the fuselage at special location tabs. The wing attachment uses a rotation bolt at the lower wing strut attachment point which makes it possible to swing the wings simply backward lengthwise to the fuselage.

7.3 Wing fold for transport

Required Tools: Screwdriver, 8,9,12 mm spanners

Parts required: None

To transport the aircraft, it is necessary to fold the wings to the transport position, i.e. to disconnect the wing front suspensions, to fold wings and fix them to the fuselage in transport position secured with transport struts (pos. 7).

For short distances the aircraft can be towed on its own landing gear behind a vehicle by means of a simple tow bar attached to the rear fuselage suspension section.

For longer distances it is recommended to transport the aircraft on a suitable trailer, either open or covered.

To prepare the aircraft for transport: (see photos on the following page

- a. Unlock and remove the rear "turtle deck" cover, and put it on the seat (pos.1,2).
- b. Close the wing tank fuel cocks.
- c. Fit simple foam protection at each end of the flapperon trailer edge
- d. Disconnect the flapperon tie rods on both wings (pos.3).
- e. Remove the split pin and nut from the leading edge wing bolt connecting the wing to the fuselage.
- f. Remove the wing bolt (either a light tap or move the wing to relieve the load on the bolt
- g. Holding the wing with one hand, fold it carefully backwards while simultaneously moving the flapperon using the other hand to prevent it from striking on fuselage cross tubes (above the baggage bay).
- h. Fix the fully folded wing to the fuselage by means of the transport struts (pos.7).
- i. Repeat above points for the second wing (pos.4).
- j. To open the wings out in preparation for the next flight, repeat the above, in reverse.

Note: if loading the aircraft onto a trailer for road transport, ensure the transport struts are fully tightened, and also have a back up strap holding both wings together, just to be sure!



7.4 Pre-flight inspection

Pre-flight inspection must be conducted before the first flight of the day. The pre-flight inspection is recommended prior to any flight or series of flights by one pilot on any given day. Prior to any flight fuel and oil quantity should be checked as a minimum.

If the aircraft has been stored outside the engine area and other points of entry should be checked for evidence of bird occupancy. All control surfaces and travel stops should be examined for wing damages. Wheel fairings are not recommended for muddy field operation due to possible mud accumulation inside the fairings. When operating from gravel fields pay special attention to propeller leading edges. Fuel caps should be monitored for any deterioration periodically to avoid fuel leakage in flight or water infiltration.

The aircraft general condition should be noted during a visual inspection of the aircraft. Inspect any signs of deterioration, distortion and any damages to fabric skin of the aircraft. In cold weather, all traces of ice, snow, and frost should be removed from the aircraft. Make sure that no ice, snow or debris is trapped between any movable control surfaces.

Make sure that all instruments are in good condition with no broken glass. Airspeed indicator should read zero, altimeter should be checked against ramp or field elevation.

Do not activate the electrical system when anyone is near the propeller to prevent injury that could possibly result from an electrical system malfunction.

Pay special attention to the propeller area – make sure the ignition and master switches are OFF before touching the propeller. Avoid touching propeller when possible to prevent possible injury resulting from electrical system malfunction.

WARNING

DO NOT FLY THE AIRCRAFT IF YOU FIND ANY DAMAGE OR PROBLEMS DURING A PRE-FLIGHT INSPECTION. ALWAYS CONSULT AUTHORISED PERSONNEL FOR REPAIRS

7.4.1 Daily Preparation

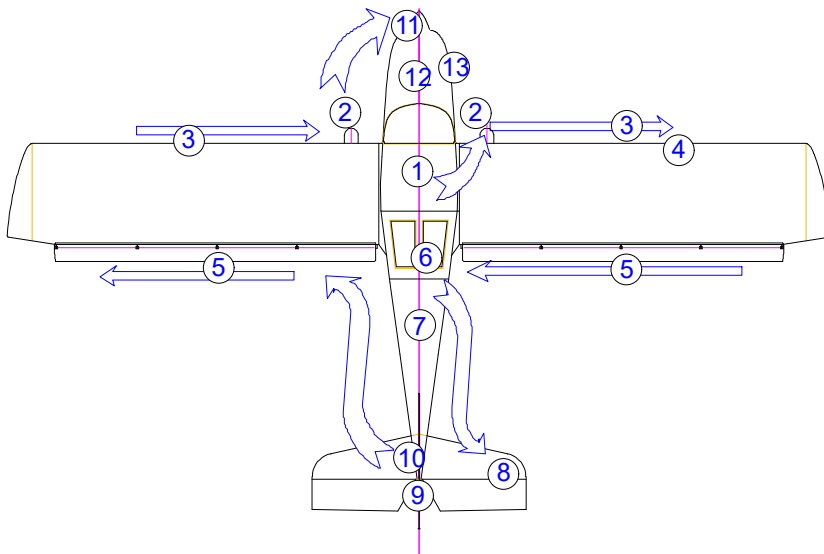

1. Cockpit

POH and other documentation	review and available to pilot
master switch	OFF
ignition	OFF
fuel valves	OPEN, fuel quantity check
instruments	INSPECT
safety belts	INSPECT
check main L/E bolts attached	INSPECT

check of flaperon tie rods	INSPECT
control stick	INSPECT , freedom of movement
rudder pedals	INSPECT , freedom of movement
brakes	INSPECT
trim	freedom of movement, proper function
engine controls	INSPECT, freedom of movement
loose objects in cockpit	remove
cockpit windows	INSPECT
door	INSPECT, shut and locked

2. Main landing gear

gear legs and attachment	INSPECT
wheels	INSPECT
brakes	INSPECT

3. Wings INSPECT – wing, struts, hinges, surface

4. Pitot tube INSPECT

5. Flaperons INSPECT –hinges, surface
freedom of movement
counterweights attachment.

6. Rear cockpit cover INSPECT, secured

7. Fuselage INSPECT

8. Stabilizer, elevator, hinges INSPECT –surface, hinges, attachment of stabilizer struts
freedom of movement of elevator and trim tab.

9. Fin, rudder, hinges INSPECT surface, attachment, freedom of movement
condition and attachment of balance tab.

10. Nose wheel INSPECT

11. Propeller INSPECT / blades, propeller hub, check of locking propeller nuts (when visible)

12. Engine Remove the top engine cowling and
INSPECT - engine mount
INSPECT - air intake, carburetors and controls
INSPECT - exhaust system, fuel lines

INSPECT – coolant, quantity (0.4 inch above bottom) - (between MIN and MAX marks), leakages –(see picture 1)



INSPECT – oil, quantity (between MIN and MAX marks), leakages. The oil level should be at least in the middle between marks when planning a long term operation.

INSPECT - fuel system, filter and carburetors

INSPECT - electrical system, ignition, cable connections

Left = Picture 1

13. Fuel

Quantity (between MIN and MAX, at least middle for longer flights)

INSPECT - draining off water and dirt from the central tank. Fuel system must be sampled daily to assure lack of contamination. Inspect the type of fuel.

Fuel caps secured, correct vent orientation – open end against air in flight.

7.4.2 Engine Warm-Up, Power Check

- wheels chocked, brakes on.
- Start the engine - see section 7.5
- warming-up to operating temperature – as per the Rotax instructions and until the oil temperature reaches 50 deg C
- temperature and pressure values - within operating limits
- If able set maximum power - speed of about 5000 RPM (3 to 5 secs.). The maximum RPM may vary with temperature and propeller setting
- check of ignition (magnetos or Lanes) – set 3,850 RPM, RPM drop should not exceed 300 on either magneto/lane nor 120 differential between magnetos.
- Idle rotation - 1600 RPM (1800rpm min for injected engines)
- All engine instrument readings must not exceed operating limits under any rating
- Remove wheel chocks for further operation, secure the aircraft

CAUTION

Perform the engine check heading upwind. Do not carry it out on loose terrain. Nobody is allowed to stand within dangerous proximity and, in particular, within the propeller arc. Select proper aircraft orientation – propeller blast can be surprisingly powerful.

CAUTION

The engine is cowled for optimum cooling during flight. Use high power settings for limited time only during ground operation to avoid engine overheating

CAUTION

After a check of engine power, cool down the engine for a short time to avoid evaporation of the cooling liquid in cylinder heads.

7.4.3 Pre-Flight Inspection

Make a brief walk around before you board the aircraft. This short inspection might discover damage or problems when occurred during the last flight. It is especially important to make this inspection when you are taking over the aircraft from other pilot.

Use chocks for main wheels when possible and practical to prevent the aircraft from moving. Always make sure that the person you asked to remove your chocks while the engine is running is aware of propeller danger. The best practise is to use chocks only for engine warm-up and engine checks and shut the engine down and remove chocks with the engine stopped. Before using chocks make sure they do not make contact with wheel spats to prevent any damage.

- | | |
|----------------------|--------------------------------------------------------|
| Cockpit | - INSPECT COCKPIT INTERIOR EQUIPMENT |
| | - INSPECT SAFETY BELTS |
| | - CONTROL SYSTEM-FREEDOM OF MOVEMENT, CHECK FOR DAMAGE |
| wings | - INSPECT WING SURFACES |
| | - INSPECT WING AND STRUTS SUSPENSIONS |
| | - INSPECT FLAPERONS. |
| Fuselage | - INSPECT |
| tail unit | - INSPECT |
| landing gear | - INSPECT |
| engine and propeller | - INSPECT. |

7.5 Engine starting 912UL/ULS (for 912iS Sport and 915iS starting, para 12.5)

Lack of oil pressure within 10 seconds after engine starting can lead to serious engine damage.

Make sure people or objects are near the propeller when starting the engine. Shout CLEAR PROP.

7.5.1 Use of External Power Supply

If the aircraft is not provided with a connection for external power supply - the external power supply may be connected to battery contacts when necessary.

7.5.2 Engine Starting

- | | |
|----------------------------------------------------------------------|---------------------------------------------------------------------------------------------------------------------------------------------------------|
| - pre-flight inspection | COMPLETED |
| - safety belts | ADJUST AND SECURE |
| - rudder pedals | FREEDOM OF MOVEMENT |
| - brakes | CHECK FUNCTION |
| - control stick | FREEDOM OF MOVEMENT |
| - trim | FREEDOM OF MOVEMENT |
| - wing flaps | FREEDOM OF MOVEMENT, RETRACTED |
| - engine control + choke | FREEDOM OF MOVEMENT |
| - instruments | CHECK OF VALUES, SETTINGS |
| - door | CLOSED, LOCKED |
| - master switch | SWITCH ON |
| - main fuel cock | OPEN |
| - Electric fuel pumps (if fitted) | ON |
| - wing tank fuel cocks | OPEN TO TANK WITH MORE FUEL |
| - choke | SWITCH ON (COLD ENGINE ONLY) |
| - throttle | 1/3 OF TRAVEL (IDLE for cold engine) |
| - control stick | PULLED (clamped between legs) |
| - brakes | ON |
| - propeller area | "CLEAR" |
| - ignition | SWITCH ON |
| - starter | SWITCH ON (10 sec as maximum without interruption, followed by a cooling period of 2 minutes) |
| - after starting the engine, adjust speed to smooth operation – IDLE | |
| - instruments | CHECK OF INDICATION (oil pressure must rise within 10 seconds. Increase of engine speed is permitted only at steady oil pressure readings above 30 PSI) |
| - choke (if fitted) | SWITCH OFF (cold engine only) |
| - avionics and other switches | SWITCH ON (transceiver, IC, turn-and- slip indicator) |

The aircraft has a tendency to roll forward easily on paved surfaces like asphalt even when the engine is at idle. A tail wind is also a significant factor. Make sure that the aircraft is not moving once the engine is started. If the aircraft is rolling and cannot be stopped with brakes, turn the engine off immediately using the ignition switch.

7.6 Taxiing

7.6.1 Prior to Taxiing

Be aware of the entire area around the aircraft to ensure that the aircraft will clear all obstruction and other aircraft. When first beginning to taxi, the brakes should be tested for proper operation as soon as the aircraft is put in motion. If braking action is unsatisfactory, the engine should be shut down immediately.

- | | |
|--------------|------------------------|
| - brakes | FUNCTIONAL CHECK |
| - stop watch | SWITCH ON, record time |

7.6.2 Taxiing

- taxiing speed is 8 KIAS maximum. Steering is performed by rudder pedals controlling the nose wheel.
- in crosswind hold ailerons „upwind“, using the control stick.
- In strong crosswind taxi the aircraft with an assisting person holding the wing by its windward side.
- When taxiing on gravel surfaces use as low engine power as possible to prevent damage to the propeller leading edges.

7.7 Normal takeoff

7.7.1 Prior to Take-Off

- brakes	BRAKES ON
- speed	3,850 RPM
- magnetos/Lanes	CHECK (R, BOTH, L, BOTH)
- carburettor heating	ACTIVATE WHEN NECESSARY (if fitted)
- choke	OFF
- trim	NEUTRAL
- wing flaps	TAKE-OFF POSITION
- master switch	ON
- ignition	ON
- main fuel valve	OPEN
- Electric fuel pumps if fitted	ON
- tank fuel valves	FUEL QUANTITY CHECK, OPEN TO BOTH OR TANK WITH MORE FUEL QUANTITY
- instruments	CHECK
- door	CLOSED, LOCKED
- safety belts	FASTENED, TIGHTENED
- controls	FREEDOM OF MOVEMENT
- runway	not occupied by another aircraft

7.7.2 Take-Off

Continuously increase engine power to maximum (max. 5800 RPM) , ensure brakes released and keep the aircraft straight using the rudder pedals.

Tailwheel variant: Apply forward joystick to just raise the tailwheel off the ground. Adopt a very slightly nose high attitude and the aircraft will want to fly off at 40-45KIAS.

Nosewheel variant: Apply gentle backpressure to the joystick. At a speed above 45 KIAS rotate the aircraft by applying further aft stick force.

Once airborne allow the aircraft to accelerate to 65 KIAS. When clear of obstacles accelerate to 65 KIAS for the climb; do not let the speed drop below 55 KIAS.

Note: for the 915iS with full throttle the use of the right rudder is much greater especially during the ground roll. Climb speed also suggested at 70 KIAS for improved forward view (see 5.2)

- throttle	FULL
- engine instruments	CHECK
- elevator control	ROTATE at 45 KIAS by applying aft stick
- initial climb speed	55 KIAS then 65 KIAS (70KIAS for 915iS)
- engine instruments	CHECK
- wing flaps	slowly FLAPS UP ABOVE 150 FT
- trimming	TRIM

WARNING

**Take-off is forbidden - if engine running is not smooth.
- if runway is occupied.**

Perform a brief magneto check before take-off after positioning the aircraft clear of other aircraft. When a magneto problem is present, do not take off. Monitor power and engine RPM early during take-off run – if the engine RPM is lower than usual (exact RPM value depends on propeller settings) or engine is not running smoothly abort the take off immediately.

If taking off from a gravel surface apply the power slowly to prevent propeller leading edge damage.

Always retract wing flaps slowly – sudden retraction of the flaps might cause a loss of attitude.

Always judge, based on your experience, whether the available runway is sufficient for normal take off. Always make a realistic estimate and be ready to abort the take-off before critical speed is reached.

7.8 Best angle of climb speed (V_x)

Climbing

- throttle 5,500 PRM MAX
- airspeed 55 KIAS (But not less than). (60KIAS - 915iS)
- engine instruments CHECK

Note: for the 915iS with full throttle the use of the right rudder is much greater especially during the climb. Climb speed also suggested at 70 KIAS for improved forward view (see 5.2)

7.9 Best rate of climb speed (V_y)

Climbing

- speed 5,500 PRM MAX
- airspeed 65 KIAS
- engine instruments CHECK

Note: for the 915iS with full throttle the use of the right rudder is much greater especially during the climb. Climb speed also suggested at 70 KIAS for improved forward view (see 5.2)

7.10 Cruise

Cruise Flight

- bring the aircraft into horizontal flight
- speed 4200-5000 RPM
- airspeed As required, approx. 90-100 KIAS.
- engine instruments CHECK
- fuel tank valves SWITCH BETWEEN TANKS (open one side and close the other) regularly

Monitor the atmospheric condition as well – do not enter an area of turbulence at a high speed. Be ready for a sudden weather change during your flight – stronger head wind can limit your ability to safely reach your planned destination.

When carburettor icing is possible, activate carburettor heating. Fuel consumption and remaining fuel on board should be monitored. Always make a comparison between planned and actual time above any waypoint.

Select carefully the flight route – avoid flying over large urban areas, large forests or large areas of water, as well as over mountains. Good landing possibilities are very limited in case of engine failure or other emergencies over these areas.

Always have a suitable landing area within gliding range. When it is necessary to cross a large area not suitable for emergency landing, always climb to the appropriate altitude to reach a suitable landing site if an emergency occurs.

Always monitor the airspace around you to prevent a mid-air collision.

WARNING

Do not forget to change the wing tank supplying the engine on regular basis to prevent fuel starvation.

A proper fuel supply to the engine is provided by a central connecting tank whilst changing fuel wing tanks.

7.11 Approach

7.11.1 Descent

- throttle INCREASED IDLE OR AS REQUIRED
- engine instruments CHECK
- carburettor heating ACTIVATE WHEN NECESSARY (if fitted)

WARNING

During long approaches and when descending from a considerable height, it is not advisable to reduce the engine throttle control to idle. In this case the engine becomes overcooled and a loss of power might occur. When descending, apply increased idle so that engine instrument readings **remain** within the limits for normal use.

7.11.2 Downwind

- power 3,000 – 4,000 RPM
- airspeed 65-75 KIAS
- engine instruments CHECK
- fuel FUEL QUANTITY CHECK, SWITCH TO TANK WITH MORE FUEL
- brakes CHECK FUNCTION BY SHORT BRAKING (check proper system resistance)
- safety belts TIGHTEN
- base leg and final leg airspace CHECK OF FREE SPACE
- landing site SITUATION

7.12 Normal landing**7.12.1 On Base Leg**

- power 3,000 RPM
- airspeed 60-65 KIAS
- engine instruments CHECK
- wing flaps TAKE-OFF (half flap)
- trimming TRIM (to keep stick pitch neutral)
- final leg airspace CHECK FOR OTHER TRAFFIC

7.12.2 On Final

- airspeed 50-55 KIAS
- power ADJUST AS NEEDED
- carburettor heating ACTIVATE WHEN NECESSARY
- engine instruments CHECK
- wing flaps LANDING (full flap or see note below)
- trimming TRIM (fully back)
- engine instruments WITHIN LIMITS
- check of clear landing site (people, obstacles).
- use controlled side slip to lose any excess height, maintain at least minimum 55 KIAS

7.12.3 Short Final

- airspeed 45-50 KIAS
- power ADJUST AS NEEDED
- carburettor heating ACTIVATE WHEN NECESSARY
- wing flaps LANDING (full flap or see note below)
- trimming TRIM (fully back)
- check of clear landing site (people, obstacles).

7.12.4 Landing

Always judge, based on your experience, whether the available runway is sufficient for A normal landing. Always make a realistic estimation and be ready for baulked landings.

At a height of about 30 ft reduce the engine speed to idle. reduce speed to 45 KIAS until the flare. When flaring at a height of 2 to 3 ft above ground, decelerate gradually by pulling the control stick backward.

When landing with a significant crosswind component do not set the flap to landing position – use take-off setting to touch down at higher speed to ensure proper control over the aircraft before it touches the ground.

Entry speed to side slip.....55-65 KIAS

7.12.5 After landing

- brakes APPLY WHEN NECESSARY
- wing flaps RETRACT
- trim TAIL HEAVY

7.12.6 Engine Stopping

- power cool down the engine at 2,000 RPM when necessary
- engine instruments CHECK
- Mags/Lanes CHECK each mag individually
- turn radio to 121,5 CHECK ELT IS NOT ACTIVATED.
- avionics and other switches OFF
- ignition OFF
- master switch OFF
- Electric pumps if fitted OFF
- avionics and other switches OFF
- main fuel valve SHUT
- tank fuel valves SHUT
- secure the aircraft chocks or other way to prevent the aircraft from unintended movement, lock the controls (using safety belts)

During normal operation the engine is usually cooled enough during the approach and landing. Make sure that all avionics and other instruments are switched off before the engine is stopped. Do not use parking brake to hold unattended aircraft, especially when the aircraft is located in the hanger.

7.12.7 Post-Flight Check

- check
 - damage to fuel system. fuel leakage
 - damage to oil system, oil leakage
 - damage to cooling circuit, liquid leakage
 - damage to electrical system, ignition
 - check the aircraft exterior for damage to:
 - fuselage - wings, flapperons
 - tail unit, - landing gear, - fiberglass covers
 - wash down the aircraft, remove dirt and bugs
 - cover the cockpit with a protective cover

7.13 Short field take-off and landing procedures

The standard take off procedure should be followed. The only difference is that the full throttle is applied with brakes on. (For tail wheel variant ensure the elevator is full up (stick back) in order to prevent the danger of the aircraft nosing over). Brakes are released when the maximum RPM is achieved from the engine. If tall obstacles are sighted at the end on the runway climb initially at best angle of climb speed 55 KIAS and adjust to best rate of climb speed of 65 KIAS when clear of the obstacles.

When approaching a short field make sure that the approach speed of 50 KIAS is carefully maintained and full flaps are set and reduce to 45 KIAS before the threshold.

7.14 Balked landing procedures

- power MAX. 5000 R.P.M
- airspeed 55 KIAS accelerating to 65 KIAS
- engine instruments CHECK
- wing flaps TAKE-OFF
- trimming TRIM
- wing flaps RETRACT AT A HEIGHT OF 150 FT

- trimming TRIM
- power MAX

7.15 Information on stalls, spins and any other useful pilot information

WARNING

Aerobatics and intentional spins are prohibited.

7.15.1 Rain

When flying in the rain, no additional steps are required. Aircraft qualities and performance are not substantially changed.

8. Aircraft Ground Handling and Servicing

8.1 Servicing fuel, oil, coolant

8.1.1 Servicing fuel

1. Verify the main switch OFF position
2. Remove fuel tank cap
3. Service with fuel of proper type until level rises to the filler openings (or any required level)
4. Replace fuel cap and check for security
5. Wash any spilled fuel from wings with a clean water
6. Repeat for opposite fuel tank.

It is not advisable to change the type of fuel during engine operation. Refuelling should be carried out in places not endangering either the aircraft, its pilots or the environment. Prior to refuelling it is always necessary to check fuel for the absence of water. Sampling should be carried out from both any jerry cans used and from all aircraft tanks via the fuel system through drain sump. When refuelling from a jerry can, a funnel must be used containing a strainer to trap impurities, or, even better, with a buckskin leather which can trap any fuel moisture content. Fuel tank draining is performed similarly by means of the drain valve.

When filling fuel into tanks, be careful to avoid staining the cockpit window panels and glass with fuel as it contains corrosive components that will cause fast deterioration and damage to cockpit glazing. Make sure that fuel tanks are closed when refuelling is finished.

8.1.2 Servicing oil

The proper oil type should be used – see this manual or engine manual. .

1. Make sure that ignition and master switch are off
2. Remove the top engine cowling.
3. Open the oil tank.
4. When a level is not between minimum and maximum marks (or not high enough for expected longer operation), add oil. Do not add oil above the MAX level – the oil will overflow out of the engine.
5. Replace oil tank cap
6. Replace the top engine cowling

The oil is to be changed every 50 or 100 hours of operation – see Maintenance manual and engine documentation for details. The first oil change is to be performed after initial 25 hours of operation of a new or overhauled engine.

8.1.3 Servicing coolant

The proper coolant type should be used – see this manual or Rotax engine manual.

1. Make sure that ignition and master switch are off
2. Remove the top engine cowling.
3. Remove the cap of the coolant tank
4. Add estimated quantity of coolant
5. Replace coolant tank cap
6. Replace the top engine cowling

8.2 Landing gear tyre dimension and pressure guide

Track.....	1.96 m
Wheel base.....	1.3 m
Main landing gear wheel tyre.....	15x6 6 ply
Tyre pressure (Mains 3K).....	29 psi
Tyre pressure (Tundra's) 18x8x6 or 21x8x6.....	12 PSI (some operators prefer a little less or a little more)
Nose wheel tyre.....	12x4 or 15x6 6 ply
Tyre pressure	29 psi (very important to maintain this pressure, check frequently)
Tail wheel.....	10 psi

8.3 Ground handling and tie-down instructions

8.3.1 Aircraft moving instruction

1. Make sure that parking brake is off
2. Check the space around the aircraft and in the proposed direction of movement
3. Push and hold the tail down - use handle located on fuselage close to rudder leading edge
4. Push the aircraft in the desired direction

Aircraft can be also ground handled using a nose wheel tow bar – optional equipment, ask your dealer for details.

CAUTION

Never push, pull, or lift the aircraft by use of control surfaces

8.3.2 Aircraft tie-down instruction

1. Turn the aircraft into wind, if possible
2. Lock the controls (using safety belts)
3. Make sure that parking brake is on, install wheel chocks when possible.
4. Attach ropes to the ring located on the lower wing surface (front strut attachment)
5. Attach rope the nose wheel
6. Attach rope to the tail (between tail skid and fuselage)
7. Secure all ropes to the tie-down points

It is recommended to install a soft foam rubber or fabric cover into the engine intakes to prevent foreign matter from accumulating inside the engine cowling. Before using make sure they do not collide with wheel fairings preventing any damage.

CAUTION

Never push, pull, or lift the aircraft by use of control surfaces

9. Parachute installation

The parachute limitation and specification are listed in the table below. The parachute is made by Magnum in CZ

	
Magnum	601 Light Speed Soft
	<u>visual</u>
Max. perm. loading (kg)	607
Max. perm. loading (lbs)	1335
Weight of system (kg)	13
Weight of system (lbs)	28.6
V max. (km/h)	300
V max. (mph)	187
Dimensions (mm)	430x200x250 mm
Dimensions (inch)	16.9x7.8x9.8
Size (m2)	130
Size (sq.ft)	1399
Repacking period (years)	6 (then every 5)
Rocket type	450 Magnum
Burn time (s)	0,6

9.1 Parachute operating data and procedures

Occupant warning – The parachute recovery system installation has been approved by the CAA on the basis that, as far as is practicable to demonstrate, it will create no hazard to the aeroplane, its occupant(s) or ground personnel whilst the system is not deployed; and that when properly maintained, the risk of malfunction, deterioration or inadvertent deployment is minimised. The CAA has not approved the system itself or considered the circumstances, if any, in which it might be deployed. The effectiveness of the system for the safe recovery of the aeroplane has not been demonstrated

9.2 Maintenance requirements for continued safe operation of the parachute

1. Refer to the manufacturers manual for operating instructions
2. Skeleton instructions for use of parachute system (not necessarily correct for every system!):
 - Only use as a last chance, when alternative is death or very serious injury.
 - Instructions for deploying. Pull handle firmly. If engine is still running turn ignitions off before deploying. If aircraft is on fire, shut fuel off and extinguish fire before deploying.
 - After deployment, brace yourself with head tucked in arms over your head (as usual aircraft brace position) before the parachute fully deploys and the opening shock is encountered.
 - Instructions for landing - Ensure engine ignitions and fuel are off, brace yourself for impact as above.
 - Instructions for accidental deployment on the ground. Pull riser to deflate parachute.
3. All maintenance carried out on the parachute system must be noted in the relevant pages of the aircraft log book, and signed by the appropriate approved signatory.
4. Keep the parachute pull handle LOCKED at all time when the aircraft is not in flight, especially during any maintenance.

10. Required Placards and Markings

10.1 Airspeed indicator range markings (these must be marked on the ASI)

Marking	MIAS	KIAS	Operations
White Arc	44-96	38-83	Flaps operating range. Lower limit is maximum weight zero thrust stall speed in the landing configuration. Upper limit is maximum speed allowable with flaps extended.
Normal flight Green arc	44-103	38-90	Normal operating range. Lower limit is maximum weight zero thrust stall with flaps retracted, upper limit is red line .
Yellow arc	104-155	90-135	Fly with caution
Red line	156 and above	136 and above	Operation not permitted

Whilst not mandatory on UK microlights, owners may decide to add a yellow Va to Vne arc on the ASI

10.2 Overview of speed limits: (indicated airspeeds)

Speed		MIAS	KIAS	Remarks
V _{NE}	Never exceed speed	155	135	V _{NE}
V _A	Manoeuvring speed	103	90	V _A
V _{FE}	Maximum wing-flaps extended speed	96	83	V _{FE}
V _{S0}	Stall speed	44	38	V _{S0}
V _{S1}	Minimum steady flight speed	50	43	V _{S1}

11. Operating limitation placards in sight of occupants

11.1 “No intentional spins”

The following placard should be located on the instrument panel

**AEROBATICS and INTENTIONAL
SPINS ARE PROHIBITED**

11.2 Miscellaneous placards and markings

Occupant warning

**This aircraft has not been certified
to an international requirement**

Engine limitations – a suitable placard with the current engine limitations will also be applicable. Coolant temp, Oil temp, Oil pressure, engine speed and engine model will be the minimum requirement.

Flight limitations – to include - max baggage weight, max occupant seat loading, Vne, Vfe, Va, Vso and loading limit (g) will also be placarded, see below 11.3

Other – all switches, levers, handles, lights or instruments shall be placarded accordingly with the operational position (e.g on/off) noted. If parachute fitted

Internal placard

**WARNING – Emergency Parachute
Pull handle to deploy. Unapproved
equipment – see POH**

**External placard near ‘chute exit area
WARNING – Danger rocket exit area**

General

**No Smoking
Approved for flight in VFR conditions**

Weighing

**BASIC EMPTY WEIGHT:
DATE OF WEIGHING:
MAXIMUM PERMITTED EMPTY WEIGHT:
MAXIMUM PERMITTED GROSS WEIGHT:
MAXIMUM FUEL LOAD WITH TWO CREW OF 86 KG EACH:
MAXIMUM COMBINED CREW WEIGHT WITH FULL FUEL TANKS (S)**

11.3 EuroFOX aircraft placards

1. Flight limitations placard – to be visible to the pilot

	V _{S0}	V _{S1}		App - glide		V _{FE}		V _A				V _{NE}
MPH MIAS	44	48	52	58	75	96	98	103	115	127	138	155
Knots KIAS	38	42	45	50	65	83	85	90	100	110	120	135

2. The EuroFOX Type Approved Microlight ASI calibration table as below.

Note: at the top end of the speed range the ASI over reads, however at the important operating speeds (landing, glide and flap range), the ASI indicated speeds are accurate for the the flight purpose.

MPH Indicated (MIAS)	35	40	45	50	60	70	80	90	100	110	120	130	140	150	160
MPH (MCAS) (calibrated)	39	42	46	50	58	67	75	84	93	102	110	120	130	139	149
KNOTS indicated (KIAS)	30	35	39	43	52	61	70	78	87	96	104	113	122	130	139
Knots (KCAS) (calibrated)	34	36	40	43	51	58	66	73	81	88	96	104	113	121	130

12. Supplementary information

12.1 Familiarization flight procedures

The familiarisation flight procedure depends on the pilot's experience. The whole familiarisation should start with the careful study of this document (Pilot Operating Handbook). The maintenance manual should be read as well.

The recommended procedure for an experienced pilot usually consists of:

- Local flight of duration of approximately 30 minutes with instructor
- 5 to 10 circuits with instructor
- 5 flights – emergency situations
- local flight of 30 minutes – solo
- 5 circuits solo

Always perform as many flights as required to be able to properly control the aircraft, the syllabus above is for reference only.

12.2 Pilot operating advisories

It is always recommended that familiarisation flights should take place on fine weather days

12.3 Further Information

Further study is available from many books, please consult EuroFOX Aviation for the latest recommendations. Another invaluable source is other pilots and instructors.

EuroFOX Aviation is a trading name of Ascent industries Ltd. Company registration nr 7731403

12.4 Starting and pre-flight checks 912UL and 912ULS

Starting, pre-flight, pre take off and pre landing check lists. This list is a guide and requirements will vary depending on the exact fit of the individual aircraft. It is recommended that the pilot compiles his or her own list using this table as a guide only.

Starting	
Park brake	On
Doors	Closed and secure
Harnesses	Secure and comfortable
Radio and TX	Off
Flap	Neutral
Master switch	On
Strobe landing light	On
Fuel tap + pump	On and on
Mags	On
Throttle + Choke	Set, choke on
Lookout	Clear prop
Start	Turn starter
Oil P & T	Check, Oil P rising?
Starter engage and volt light	Light out
Pre-flight / Take off	
Throttle	2000 rpm
Flying Controls	Full and free
Doors and Harness	Closed, locked, secure
Stowage items	Secure
Radio TX	On
Trim	Set take off
T & P's	All in range
RPM – Mag check	Up to 3800 rpm check
Choke	Off
Fuel and pump	Sufficient on and on
Flaps	Set take off
Lookout and line up	Check all clear
Landing	
Brakes	Check pressure OK
Undercarriage	Check no damage
Propeller	Set fine if VP
Fuel and pump	Sufficient on and on
Flaps	Set landing as POH
Landing light	On
Instruments	T & P's all ok
Carb heat	Set as required
Doors and harnesses	Closed, locked, secure
Park and shutdown	Hope you enjoyed the flight

12.5 Starting and pre-flight checks landing and shutdown procedure 912iS Sport and 915iS

Start

1. Fuel on all 3 taps
2. Brakes on
3. Throttle to 25%
4. Oil flap pull out and closed (if fitted)
5. Check throttle friction lock engaged
6. Battery on
7. One fuel pump on
8. Both lanes on, wait for lane light to go out
9. Turn key to on, press start button
10. Idle 2000-2200rpm
10. Avionics and instruments on

Pre take off

1. Throttle 2200 rpm, hold on brakes if required
2. Flying Controls - Full and free
3. Doors and Harness Closed, locked, secure
4. Stowage items - Secure
5. Radio TX – On correct 1st and 2nd frequency
6. Trim - Set take off
7. T & P's - All in range
8. RPM – lane check Up to 2500 rpm check, hold with brakes
9. Second fuel pump on – fuel sufficient and on – all 3 taps
10. Flaps Set take off – typically ½
11. Lookout, call ATC and line up Check all clear

After take off

1. Re trim and flaps to zero
2. Check fuel sufficient
3. at 1000 ft turn one fuel pump off

Before landing

1. Brakes - off
2. Flaps and trimmer - Set landing as POH
3. Landing light - On if fitted
4. Second fuel pump on
5. Instruments T & P's all ok
6. Doors and harnesses - Closed, locked, secure

Shutdown

1. Hold on brakes
2. Allow engine to cool down, open oil flap (push in) if fitted
3. Strokes and avionics off
4. Throttle out and friction locked
5. Both lanes off
6. Both fuel pumps off
7. Key to off
8. Fuel taps closed

12.6 Autopilot

If an autopilot is fitted the following placard must be fitted and visible to the pilots:

“Autopilot operation is not permitted below 1000ft AGL”

The autopilot is powered from a separate switch and fuse/circuit breaker fitted to the instrument panel. This must be ON for the autopilot to function, and may be used to disable the autopilot in case of malfunction.

The autopilot should be enabled or disabled in normal use through the specific control or the EFIS panel, depending on exact fitment. The autopilot status is also visible on the appropriate device.

The autopilot may be overridden using the normal flight controls with minor additional effort.

In the case of the Dynon and MGL systems, where a breakable over-load pin is used, it is possible that this may fail due to excess loads – if the autopilot appears to not be functioning, despite the visible ON indication, this should be suspected and the autopilot turned OFF pending further inspection.

The autopilot manufacturer pilot information must be appended to this manual and the service information appended to the Maintenance Manual.

The appropriate autopilot checklists must be used.

Generic Autopilot Checklist

Before takeoff checklist:

- 1) Autopilot - ENGAGE
- 2) Flight controls - CHECK (verify autopilot can be overpowered in both pitch and roll)
- 3) Autopilot Disconnect Button - (verify autopilot disengages)
- 4) Flight controls - CHECK (verify autopilot servos are disengaged from pitch and roll controls, and all controls move freely)
- 5) Elevator trim control - SET FOR TAKEOFF

Garmin Checklist

Before takeoff checklist:

- 1) Autopilot - ENGAGE (using AP/CWS button, or AP button on mode controller)
- 2) Flight controls - CHECK (verify autopilot can be overpowered in both pitch and roll)
- 3) AP DISC button - PRESS (verify autopilot disengages)
- 4) Yaw damper - OFF (if installed) (verify yaw damper disengages)
- 5) Flight director - SET FOR TAKEOFF (select IAS or VS mode or push FD Button to turn off the Flight Director)
- 6) Flight controls - CHECK (verify autopilot servos are disengaged from pitch, roll, and yaw controls, and all controls move freely)
- 7) Elevator trim control - SET FOR TAKEOFF